



AM PRO/21586

Toe, camber and turn angles kit Toe-, camber- och vridvinkelsats Spur-, Sturz- und Drehwinkelsatz



#	Article #	Order #	Pcs.	EN	SE	DE
1	AM135	10265	2	Turn angle gauge	Vridvinkelskala	Drehwinkelskala
2	AM20-D 1	10492	2	Diode laser+charger in case	Diodlaser+transformator i väska	Diodlaser+Transf. mit Tasche
3	AM301	10525	1	Angle gauge camber/caster/KPI	Vinkelmätare camber/caster/KPI	Winkelmessgerät Sturz/Nachlauf
4	AM34 A	10540	4	Measuring scale	Mätskala	Mess-Skala
5	AM5-1750 A	10586	2	Gauge extension 1750 mm	Mätstång 1750 mm	Mess-Stange 1750 mm
6	AM5-1750 B	10587	2	Gauge extension 1750 mm with bubble	Mätstång 1750 mm med libell	Mess-Stange 1750 mm mit Libelle
7	JT120 A	11904	2	Self centering frame gauge	Självcentrerande mätlinjal	Selbstzentrierendes Messlineal
8	JT5-3	12036	2	Hanger 320 mm	Upphängningsstång 320 mm	Aufhänge-Stange 320 mm
9	JT5-6	12040	4	Hanger 620 mm	Upphängningsstång 620 mm	Aufhänge-Stange 620 mm
10	AM268 A	13762	2	Non friction plate	Antifriktionsplatta	Antifriktionsplatte
11	AM10 B	14303	2	Wheel adapter universal 16"-24"	Hjuladapter universal 16"-24"	Radhalter universal 16"-24"
12	AM1855	15169	1	JOSAM laser AM software for wheel alignment, frame measurement and tire diagnose	JOSAM laser AM mjukvara för hjulinställning, rammätning och däckdiagnos	JOSAM laser AM Software für Radeinstellung, Rahmen-Vermessung und Riefen-Diagnose
13	WAS200	21720	1	Trolley for equipment	Vagn för utrustning	Wagen für Ausrüstung



PC-hardware is not included. For the latest PC-requirements please contact your representative.

PC-hårdvara ingår ej. För senaste PC-rekommendation, kontakta Er återförsäljare.

PC-Hardware ist nicht inbegriffen. Für techn. Anforderungen fragen Sie bitte Ihren Wiederverkäufer.



AM PRO/21586

Toe, camber and turn angles kit
Toe-, camber- och vridvinkelsats
Spur-, Sturz- und Drehwinkelsatz

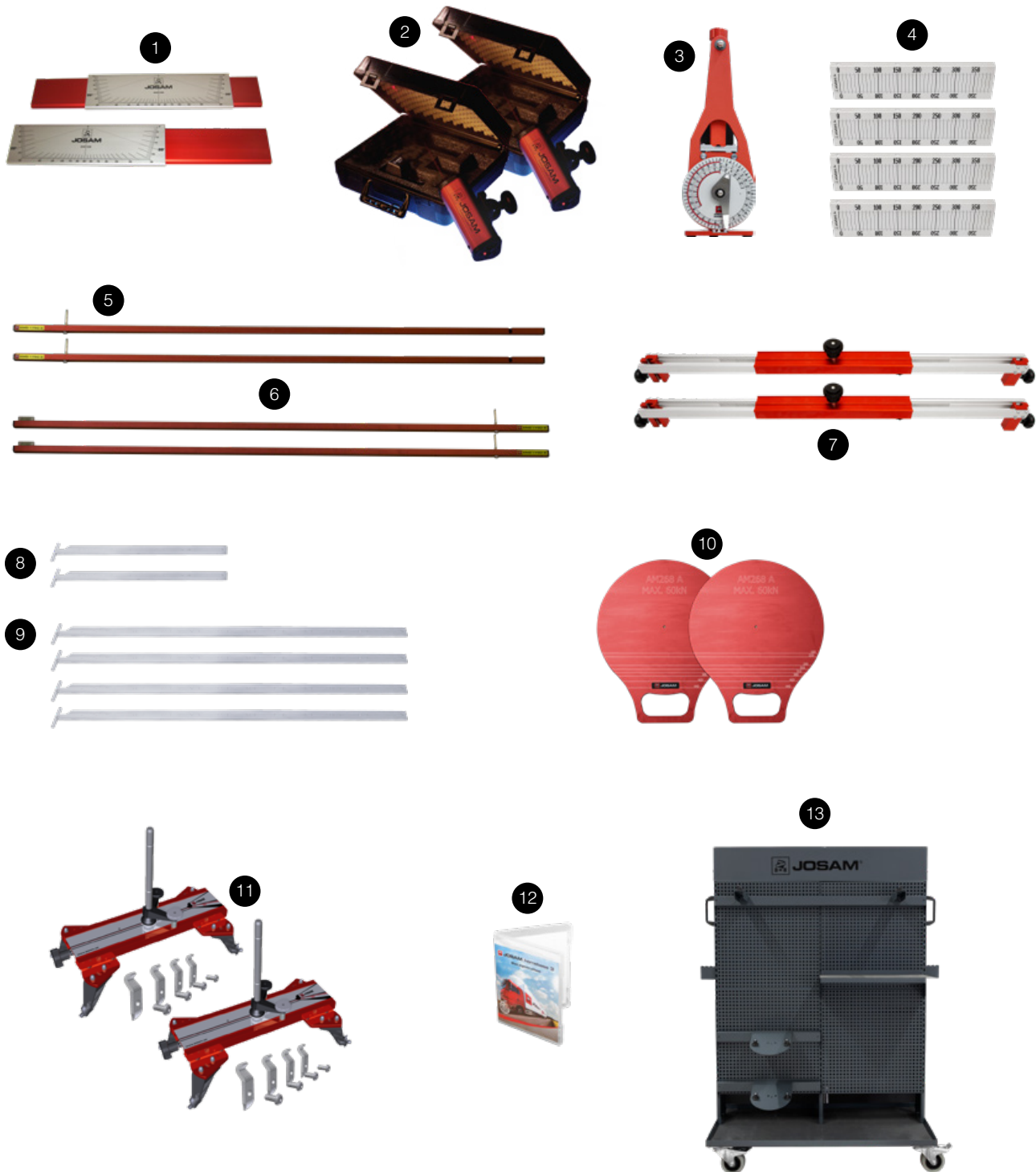



AM CORE/21585

Toe and out-of-square kit

Toe- och snedställningssats

Spur- und Schrägstellungssatz



#	Article #	Order #	Pcs.	EN	SE	DE
1	AM20-D 1	10492	2	Diode laser+charger in case	Diodlaser+transformator i väska	Diodlaser+Transf. mit Tasche
2	AM34 A	10540	4	Measuring scale	Mät skala	Mess-Skala
3	AM5-1750 A	10586	2	Gauge extension 1750 mm	Mätstång 1750 mm	Mess-Stange 1750 mm
4	AM5-1750 B	10587	2	Gauge extension 1750 mm with bubble	Mätstång 1750 mm med libell	Mess-Stange 1750 mm mit Libelle
5	JT120 A	11904	2	Self centering frame gauge	Självcentrerande mätlinjal	Selbstzentrierendes Messlineal
6	JT5-3	12036	2	Hanger 320 mm	Upphångningsstång 320 mm	Aufhänge-Stange 320 mm
7	JT5-6	12040	4	Hanger 620 mm	Upphångningsstång 620 mm	Aufhänge-Stange 620 mm
8	AM268 A	13762	2	Non friction plate	Antifriktionsplatta	Antifriktionsplatte
9	AM10 B	14303	2	Wheel adapter universal 16"-24"	Hjuladapter universal 16"-24"	Radhalter universal 16"-24"
10	AM1855	15169	1	JOSAM laser AM software for wheel alignment, frame measurement and tire diagnose	JOSAM laser AM mjukvara för hjulinställning, rammätning och däckdiagnos	JOSAM laser AM Software für Radeinstellung, Rahmenvermessung und Riefen-Diagnose
11	WAS200	21720	1	Trolley for equipment	Vagn för utrustning	Wagen für Ausrüstung



PC-hardware is not included. For the latest PC-requirements please contact your representative.

PC-hårdvara ingår ej. För senaste PC-rekommendation, kontakta Er återförsäljare.

PC-Hardware ist nicht inbegriffen. Für techn. Anforderungen fragen Sie bitte Ihren Wiederverkäufer.



AM CORE/21585

Toe and out-of-square kit

Toe- och snedställningssats

Spur- und Schrägstellungssatz

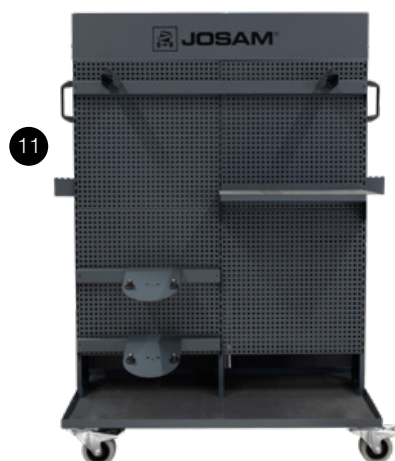
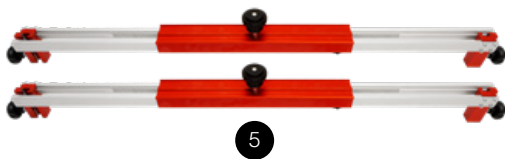
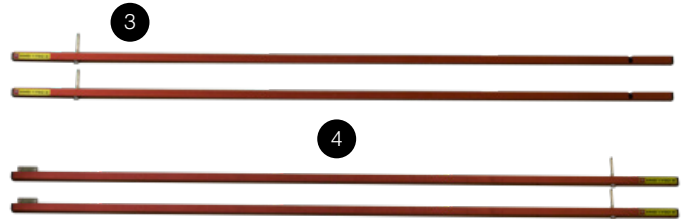
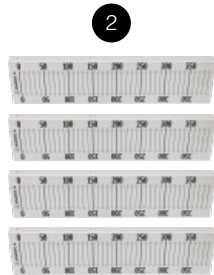



AM CORE LITE/21581

Toe and out-of-square kit

Toe- och snedställningssats

Spur- und Schrägstellungssatz



#	Article #	Order #	Pcs.	EN	SE	DE
1	AM20-D 1	10492	2	Diode laser+charger in case	Diodlaser+transformator i väska	Diodlaser+Transf. mit Tasche
2	AM34 A	10540	4	Measuring scale	Mätskala	Mess-Skala
3	AM5-1750 A	10586	2	Gauge extension 1750 mm	Mätstång 1750 mm	Mess-Stange 1750 mm
4	AM5-1750 B	10587	2	Gauge extension 1750 mm with bubble	Mätstång 1750 mm med libell	Mess-Stange 1750 mm mit Libelle
5	JT120 A	11904	2	Self centering frame gauge	Självcentrerande mätlinjal	Selbstzentrierendes Messlineal
6	JT5-3	12036	2	Hanger 320 mm	Upphångningsstång 320 mm	Aufhänge-Stange 320 mm
7	JT5-6	12040	4	Hanger 620 mm	Upphångningsstång 620 mm	Aufhänge-Stange 620 mm
8	AM268 A	13762	2	Non friction plate	Antifriktionsplatta	Antifriktionsplatte
9	AM10 B	14303	2	Wheel adapter universal 16"-24"	Hjuladapter universal 16"-24"	Radhalter universal 16"-24"
10	AM1855	15169	1	Laser AM software for wheel alignment, frame measurement and tire diagnose	Laser AM-mjukvara för hjulinställning, rammätning och däckdiagnos	Laser AM Software für Radeinstellung, Rahmen-Vermessung und Riefen-Diagnose

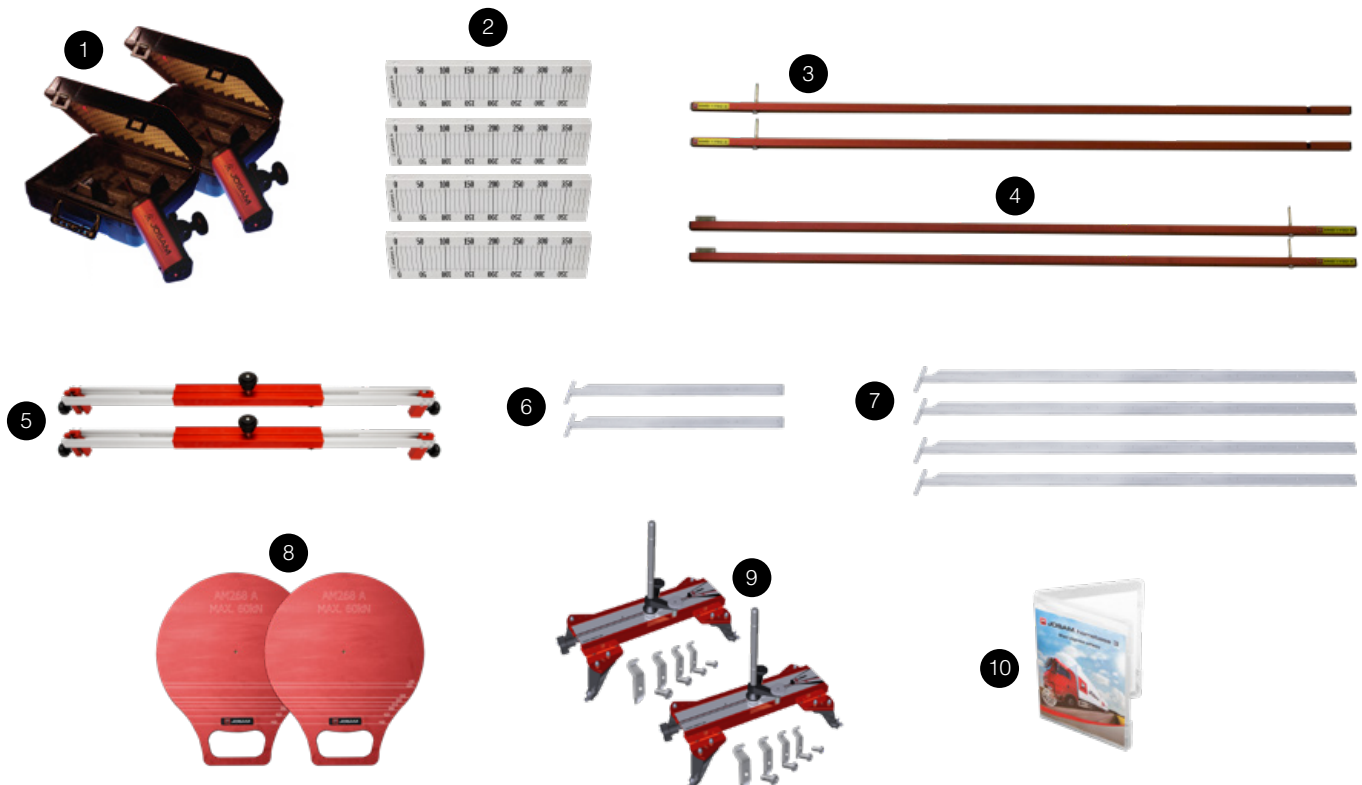

Storage is not included.

Förvaring ingår ej.

Lagerung ist nicht inbegriffen.

PC-hardware is not included. For the latest PC-requirements please contact your representative.

PC-hårdvara ingår ej. För senaste PC-rekommendation, kontakta Er återförsäljare.

PC-Hardware ist nicht inbegriffen. Für techn. Anforderungen fragen Sie bitte Ihren Wiederverkäufer.



Laser AM Pro/Core — Accessories / Tillbehör / Zubehör

AM TWIN K B/21596

Additional kit for twin steer

Tilläggsats för dubbelt styrande framaxel

Ergänzungs-Satz für Doppellenkachser



#	Article #	Order #	Pcs.	EN	SE	DE
1	AM268 A	13762	2	Non friction plate	Antifriktionsplatta	Antifriktionsplatte
2	AM10 B	14303	2	Wheel adapter universal 16"-24"	Hjuladapter universal 16"-24"	Radhalter universal 16"-24"
3	WAS1001	21709	2	Bracket for wheel adapter	Hållare för hjuladapter	Befestigung für Radhalter

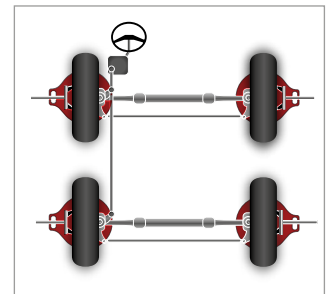
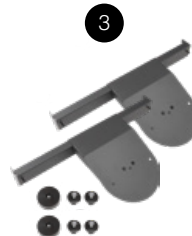
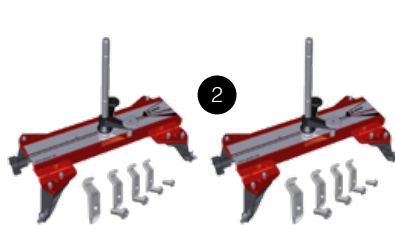

CA TRAILER K/72104

Additional kit for trailer and semi-trailer

Tilläggsats för släp och semi-trailer

Ergänzungssatz für Anhänger und Auflieger



#	Article #	Order #	Pcs.	EN	SE	DE
1	CA TRAILER K	72104	1	Kit for trailer and semi-trailer	Sats för släp och semi-trailer	Satz für Anhänger und Auflieger

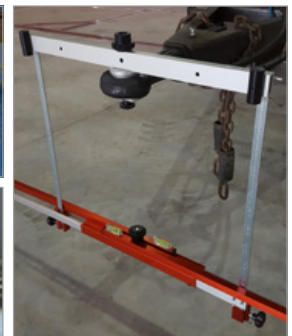
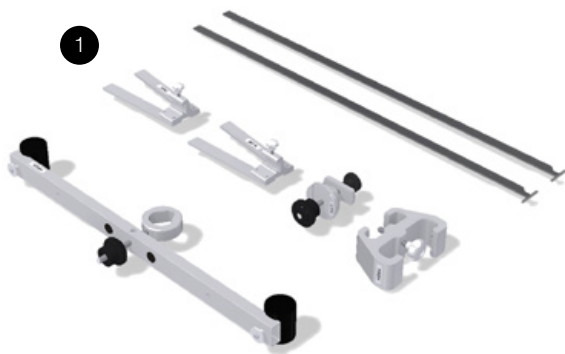



AM BUS K/15877

Additional kit for buses — JOSAM Laser AM/Truckaligner

Tilläggsats för bussar — JOSAM Laser AM/Truckaligner

Ergänzungssatz für Busse — JOSAM Laser AM/Truckaligner



#	Article #	Order #	Pcs.	EN	SE	DE
1	AM BUS K	15877	1	Additional kit for buses	Tilläggsats för bussar	Ergänzungssatz für Busse





Accessories Tillbehör Zubehör

Note:

Pcs. = Quantity of units for article number
 Rec. = Recommended order quantity
 Sheet = Detailed product sheet number

Obs:

Pcs. = Antal enheter per artikelnummer
 Rec. = Rekommenderat orderantal
 Sheet = Nummer för detaljerat produktblad

Hinweis:











Pcs. = Stückzahl für Artikelnummer
 Rec. = Empfohlene Bestellmenge
 Sheet = Nummer für das Produktdatenblatt

	Adapter MAN TGA, Renault D narrow, Iveco Stralis, MB Actros (from 2011) & Antos, Volvo FE	Article # AM1622
	Pcs: 1 Rec: 2 Sheet: 8:04	Order # 10360
	Adapter Volvo FH/FM (to 2011)	Article # AM1780
	Pcs: 1 Rec: 2 Sheet: 8:04	Order # 10439
	Adapter DAF CF/XF (Gen. 1 to 2012)	Article # AM1790
	Pcs: 1 Rec: 2 Sheet: 8:04	Order # 10444
	Adapter Volvo FH/FMX/FM, Renault T & T-High	Article # AM1854
	Pcs: 1 Rec: 2 Sheet: 8:04	Order # 15167
	Adapter DAF CF/XF (Gen. 2 - Euro 6 from 2012)	Article # AM1861
	Pcs: 1 Rec: 2 Sheet: 8:04	Order # 15658
	Adapter Renault Premium Euro 6	Article # AM1862
	Pcs: 1 Rec: 2 Sheet: 8:04	Order # 15767
	Adapter Scania series 4/5/6	Article # AM1879
	Pcs: 1 Rec: 2 Sheet: 8:04	Order # 16383
	Adapter Ford F-Max (left), Ford Cargo 1833/1842 (left), Ford Legacy 1833 (left)	Article # AM1891
	Pcs: 1 Rec: 1 Sheet: 8:04	Order # 21202
	Adapter Ford F-Max (right), Ford Cargo 1833/1842 (right), Ford Cargo 4142, Ford Legacy 1833 (right), Iveco S-way	Article # AM1892
	Pcs: 1 Rec: 1/2 Sheet: 8:04	Order # 21292
	Front adapter extender	Article # AM1895
	Pcs: 1 Rec: 2 Sheet: 8:04	Order # 21363

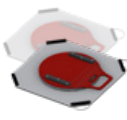
	Magnet bracket for frame, right	Article # AM1227-1 A
	Pcs: 1 Rec: 1 Sheet: 8:04	Order # 10234
	Magnet bracket for frame, left	Article # AM1227-2 A
	Pcs: 1 Rec: 1 Sheet: 8:04	Order # 10235
	Magnet bracket for frame gauge	Article # TC-1029
	Pcs: 1 Rec: 2 Sheet: 8:04	Order # 71349
	Stabilizer for frame	Article # JT119
	Pcs: 1 Rec: 4 Sheet: 8:04	Order # 11903
	Magnet bracket	Article # TC-15439
	Pcs: 1 Rec: 2 Sheet: 8:04	Order # 70693
	Sliding scale for AM34A mm/m	Article # AM84 A
	Pcs: 1 Rec: 2	Order # 10650
	Magnet wheel adapter	Article # CA ALU K
	Pcs: 2 Rec: 1 Sheet: 8:13	Order # 72103
	Magnet wheel adapter for flat surfaces	Article # CA1243
	Pcs: 1 Rec: 2 Sheet: 8:13	Order # 72243
	Universal wheel adapter 13-19"	Article # AM8 B
	Pcs: 1 Rec: 2 Sheet: 8:13	Order # 14287
	Foot plate set. Extend your gripping range to 30" on your AM10 B and JT636. Set is for one wheel adapter.	Article # AM 1518 K
	Pcs: 1 Rec: 1 Sheet: 8:13	Order # 10153



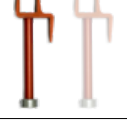



Accessories Tillbehör Zubehör

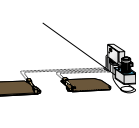
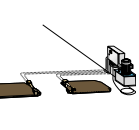
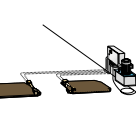
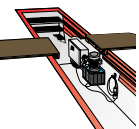
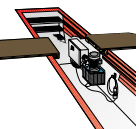
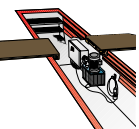

	Turn angle gauge	Article # AM135 Order # 10265
Pcs: 1 Rec: 2 Sheet: 8:10		
	Angle gauge camber, caster, KPI	Article # AM301 Order # 10525
Pcs: 1 Rec: 1 Sheet: 8:10		
	Non-friction plate Ø 400 mm	Article # AM268 A Order # 13762
Pcs: 1 Rec: 2 Sheet: 8:14		
	Non-friction plate Ø 500 mm	Article # AM245 A Order # 14475
Pcs: 1 Rec: 2 Sheet: 8:14		
	Turntable with non-friction plate	Article # JT 295 A Order # 14478
Pcs: 1 Rec: 2 Sheet: 8:14		
	Drive on ramp	Article # JT753 Order # 21022
Pcs: 1 Rec: 2 Sheet: 8:14		
	Wooden plate for height compensation	Article # TC-12860 Order # 70546
Pcs: 1 Rec: 2 Sheet: 8:14		
	Spirit level 1000 mm	Article # AM542 Order # 10595
Pcs: 1 Rec: 1		
	Hanger for spirit level 160 mm	Article # AM98 K Order # 10689
Pcs: 1 Rec: 2		
	Magnet hanger	Article # JT170 Order # 11929
Pcs: 1 Rec: 2		

	Bar for break pedal	Article # AM325 Order # 10530
Pcs: 1 Rec: 1 Sheet: 8:10		
	Hand tool for tie-rod	Article # 2MB-KEY Order # 15071
Pcs: 1 Rec: 1 Sheet: 14:10		
	Air impact hammer for tie-rod	Article # BAT-TRUCK EVO Order # 21229
Pcs: 1 Rec: 1 Sheet: 14:10		
	Ball joint extractor, 3.3-5.8 ton	Article # I-BE57-39 Order # 10949
Pcs: 1 Rec: 1 Sheet: 14:10		
	Ball joint extractor, 11 ton	Article # I-BEU110 Order # 21025
Pcs: 1 Rec: 1 Sheet: 14:10		
	Hydraulic bushing tool kit	Article # I-EBH18 Order # 10975
Pcs: 1 Rec: 1 Sheet: 14:10		
	20 ton C-clamp for spring bolts and bushings	Article # JO 1502 K Order # 11106
Pcs: 1 Rec: 1 Sheet: 14:10		
	Mandrel set for bushings	Article # JO 1502 OPT Order # 11107
Pcs: 1 Rec: 1 Sheet: 14:10		
	Hydraulic hand pump	Article # I-PH70A-600 Order # 21026
Pcs: 1 Rec: 1 Sheet: 14:10		
	Box with shims	Article # JO 2160 K Order # 11120
Pcs: 1 Rec: 1 Sheet: 14:10		

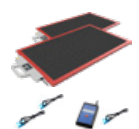

Accessories Tillbehör Zubehör

	Play detector for floor and service pit, 380 V Pcs: 1 Rec: 1 Sheet: 10:03	Article # AM 800 K Order # 10169
	Play detector for floor and service pit, 115 V Pcs: 1 Rec: 1 Sheet: 10:03	Article # AM 800 K 115 V Order # 10170
	Play detector for floor and service pit, 230 V Pcs: 1 Rec: 1 Sheet: 10:03	Article # AM 800 K 230 V Order # 14267
	Play detector for service pit, 380 V Pcs: 1 Rec: 1 Sheet: 10:04	Article # AM 900 K Order # 10172
	Play detector for service pit, 115 V Pcs: 1 Rec: 1 Sheet: 10:04	Article # AM 900 K 115 V Order # 10173
	Play detector for service pit, 230 V Pcs: 1 Rec: 1 Sheet: 10:04	Article # AM 900 K 230 V Order # 14268
	Mounting kit for AM 800 K/AM 900 K Pcs: 1 Rec: 1	Article # AM 975 K Order # 10175
	Truck roller 25 ton Pcs: 1 Rec: 1 Sheet: 8:51	Article # V1250B Order # 21338
	Truck roller 15 ton Pcs: 1 Rec: 1 Sheet: 8:51	Article # V350B Order # 21331
	Axle weighing set (6 tonnes) with hand-held terminal Pcs: 1 Rec: 1 Sheet: 8:52	Article # SC-12 HT Order # 21350

	Axle weighing set (6 tonnes) for PC Pcs: 1 Rec: 1 Sheet: 8:52	Article # SC-12 PC Order # 21351
	Trolley for equipment Pcs: 1 Rec: 1	Article # WAS200 Order # 21720
	Bracket for wheel adapter Pcs: 1 Rec: 2	Article # WAS1001 Order # 21709